



MSW2T-2060-195/MSW2T-2061-195/MSW2T-2062-195

SP2T Surface Mount High Power PIN Diode Switch

Features:

- Surface Mount SP2T Switch – 5mm x 8mm x 2.5mm
- Industry Leading Average Power Handling – 100W CW
- High Voltage rating greater than 500V support Higher RF Peak Power - >550W
- Low Insertion Loss (< 0.25 dB) and High IP3 (>66 dBm)
- High Bias Voltage supports High Linearity
- RoHS Compliant

Description:

The MSW2T-206x-195 series of surface mount High Power PIN Diode switches leverage high reliability hybrid manufacturing processes which yield proven superior performance to both MMIC and Glass Carrier based technologies. The hybrid design approach permits precise PIN Diode selection to optimize RF performance while maintaining competitive cost targets. The small form factor (8mm x 5mm x 2.5mm) offers world class power handling, low insertion loss, and superior intermodulation performance exceeding all competitive technologies.

Typical Applications:

- Radar T/R Modules
- Switch Bank Filters
- Mil-Com Radios

The MSW2T206x-195 series of High Power SP2T switches are intended for use in high power, high reliability, mission critical applications across the HF to C Band frequency ranges. The manufacturing process has been proven through years of extensive use in high reliability applications.

The MSW2T-206x-195 family of SP2T switches are fully RoHS compliant.

ESD and Moisture Sensitivity Level Rating:

The MSW2T-206X-195 carries an ESD ratings of Class 1C, Human Body Model (HBM) and a moisture sensitivity rating of MSL 1.

MSW2T-2060-195 Specifications @ $Z_o = 50\Omega$; $T_a = +25^\circ\text{C}$

Parameter	Symbol	Units	Test Conditions	Min Value	Typical Value	Max Value
Frequency	F	MHz		20		1,200
J0-J1 or J0-J2 Insertion Loss (Note 1)	IL	dB	-180V @ -50mA (ON) +1V @ +25 mA (OFF)		0.25	0.35
J0-J1 or J0-J2 Return Loss (Note 1)	RL	dB	-180V @ -50mA (ON) +1V @ +25 mA (OFF)	20	23	
J0-J1 or J0-J2 Isolation (Note 1)	ISO	dB	-180V @ -50mA (ON) +1V @ +25 mA (OFF)	49	53	
CW Incident Power (Note 1)	P inc (CW)	dBm	-180V @ -50mA (ON) +1V @ +25 mA (OFF) 1.5:1 Source & Load VSWR		50	
Peak Incident Power (Note 1)	P inc (Pk)	dBm	-180V @ -50mA (ON) +1V @ +25 mA (OFF) 1.5:1 Source & Load VSWR		57 @ 10 μs Pulse, 1% Duty	
Switching Speed	Ts	ns	(10%-90%) RF Voltage TTL rep rate = 100 kHz		750	1,000
Input 3 rd Order Intercept Point	IIP3	dBm	F1 = 2,000 MHz F2 = 2,010 MHz P1 = P2 = +40 dBm -180V @ -50 mA (ON) +1V @ +25 mA (OFF)	60	65	

MSW2T-2061-195 Specifications @ $Z_o = 50\Omega$; $T_a = +25^\circ\text{C}$

Parameter	Symbol	Units	Test Conditions	Min Value	Typical Value	Max Value
Frequency	F	MHz		200		4,500
J0-J1 or J0-J2 Insertion Loss (Note 1)	IL	dB	-180V @ -50mA (ON) +1V @ +25 mA (OFF)		0.5	0.7
J0-J1 or J0-J2 Return Loss (Note 1)	RL	dB	-180V @ -50mA (ON) +1V @ +25 mA (OFF)	14	16	
J0-J1 or J0-J2 Isolation (Note 1)	ISO	dB	-180V @ -50mA (ON) +1V @ +25 mA (OFF)	32	35	
CW Incident Power (Note 1)	P inc (CW)	dBm	-180V @ -50mA (ON) +1V @ +25 mA (OFF) 1.5:1 Source & Load VSWR		50	
Peak Incident Power (Note 1)	P inc (Pk)	dBm	-180V @ -50mA (ON) +1V @ +25 mA (OFF) 1.5:1 Source & Load VSWR		57 @ 10 μs Pulse, 1% Duty	
Switching Speed	Ts	ns	(10%-90%) RF Voltage TTL rep rate = 100 kHz		750	1,000

Input 3 rd Order Intercept Point	IIP3	dBm	F1 = 2,000 MHz F2 = 2,010 MHz P1 = P2 = +40 dBm -180V @ -50 mA (ON) +1V @ +25 mA (OFF)	60	65	
---	------	-----	--	----	----	--

MSW2T-2062-195 Specifications @ Zo = 50Ω; Ta = +25°C

Parameter	Symbol	Units	Test Conditions	Min Value	Typical Value	Max Value
Frequency	F	MHz		1,500		6,500
J0-J1 or J0-J2 Insertion Loss (Note 1)	IL	dB	-180V @ -50mA (ON) +1V @ +25 mA (OFF)		-0.7	-0.9
J0-J1 or J0-J2 Return Loss (Note 1)	RL	dB	-180V @ -50mA (ON) +1V @ +25 mA (OFF)	-11	-13	
J0-J1 or J0-J2 Isolation (Note 1)	ISO	dB	-180V @ -50mA (ON) +1V @ +25 mA (OFF)	-31	-34	
CW Incident Power (Note 1)	P inc (CW)	dBm	-180V @ -50mA (ON) +1V @ +25 mA (OFF) 1.5:1 Source & Load VSWR		+50	
Peak Incident Power (Note 1)	P inc (Pk)	dBm	-180V @ -50mA (ON) +1V @ +25 mA (OFF) 1.5:1 Source & Load VSWR		+57 @ 10 uS Pulse, 1% Duty	
Switching Speed	Ts	ns	(10%-90%) RF Voltage TTL rep rate = 100 kHz		750	1,000
Input 3 rd Order Intercept Point	IIP3	dBm	F1 = 2,000 MHz F2 = 2,010 MHz P1 = P2 = +40 dBm -180V @ -50 mA (ON) +1V @ +25 mA (OFF)	60	65	

MSW2T-206X-195 SP2T Schematic

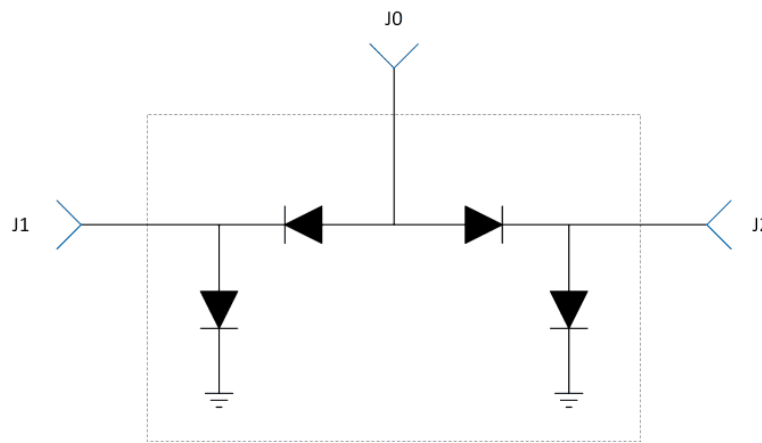

MSW2T-2061-195

MSW2T-206X-195 Driver Interface Schematic and Associated Truth Table

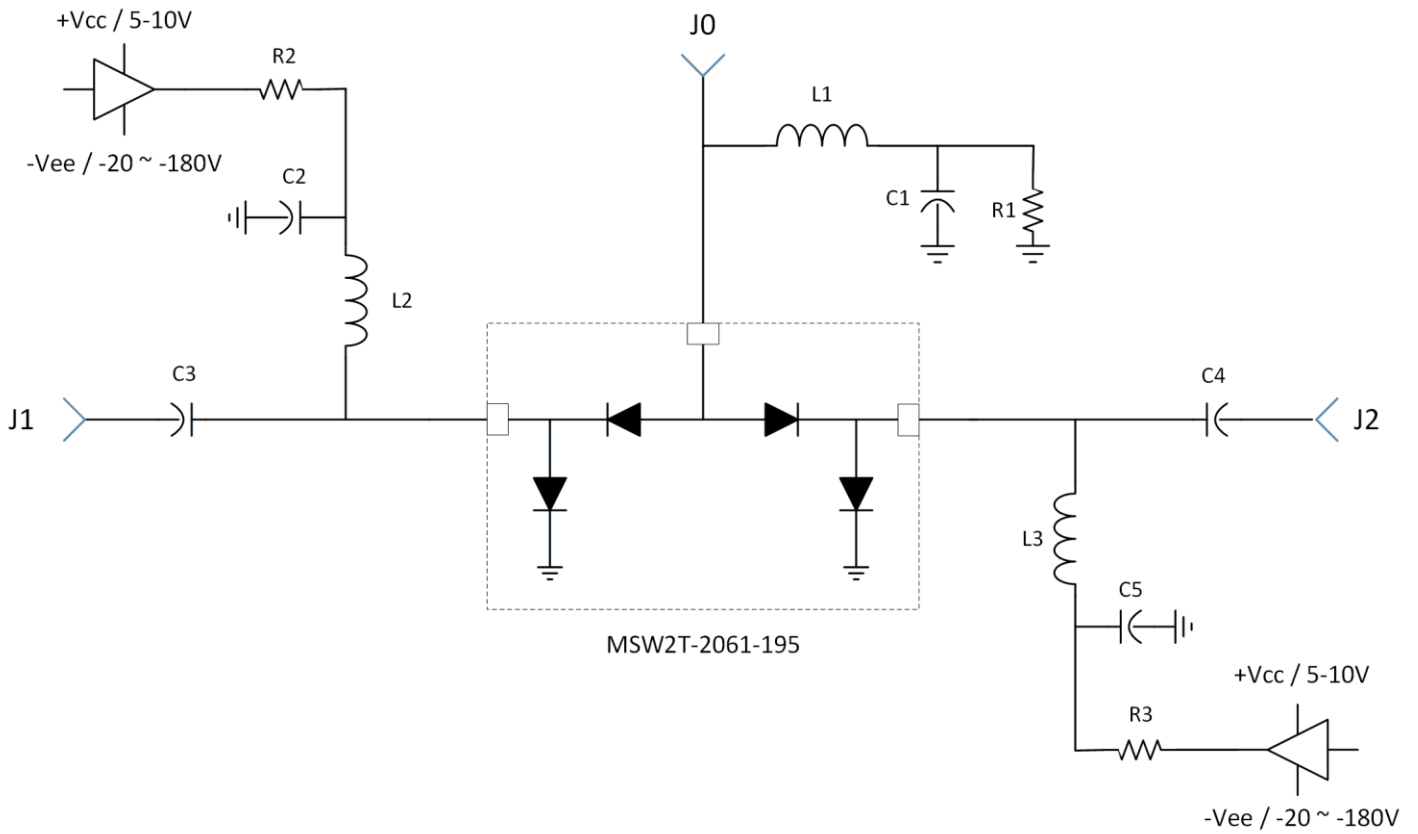

RF Biasing Network Values

Part	F (MHz)	DC Blocking Caps	Inductors	RF Bypass Caps
MSW2T-2060-195	50 – 1,000	0.1 uF	4.7 uH	0.1 uF
MSW2T-2061-195	400 – 4,000	27 pF	82 nH	270 pF
MSW2T-2062-195	2,000 – 6,000	22 pF	33 nH	33 pF

RF Truth Table

RF State	J1 Bias	J2 Bias
J1-J0 "ON" & J2-J0 "OFF"	-180 V @ -50 mA	+1 V @ +25 mA
J1-J0 "OFF" & J2-J0 "ON"	+1 V @ +25 mA	-180 V @ -50 mA

Minimum Reverse Bias Voltage @ J1, J2 Ports vs Frequency for 100 W CW

Operations:

Part	F (MHz) & V _{DC}	F (MHz) & V _{DC}	F (MHz) & V _{DC}	F (MHz) & V _{DC}	F (MHz) & V _{DC}	F (MHz) & V _{DC}
MSW2T-2060-195	20 MHz -180 V	100 MHz -150 V	200 MHz -75 V	400 MHz -55 V	1,000 MHz -35 V	4,000 MHz N/A
MSW2T-2061-195	20 MHz N/A	100 MHz N/A	200 MHz -150 V	400 MHz -110 V	1,000 MHz -55 V	4,000 MHz -25 V
MSW2T-2062-195	1,000 MHz -55 V	2,000 MHz -28 V	3,000 MHz -28 V	4,000 MHz -28 V	5,000 MHz -28 V	6,000 MHz -28 V

Note: N/A denotes that the condition is outside of the normal operating frequency range.

MSW2T-206X-195 Absolute Maximum Ratings @ T_A = +25 °C (unless otherwise denoted)

Parameter	Absolute Maximum Value
Forward Current @ J1 or J2	+/- 250 mA
Reverse Voltage @ J1 or J2	-300 V
Forward Diode Voltage	1.2 V @ 250 mA
Operating Temperature	-65 °C to +125 °C
Storage Temperature	-65 °C to +150 °C
Junction Temperature	+175 °C
Assembly Temperature	+260 °C for 10 seconds
CW Incident Power Handling Source & Load VSWR = 1.5 : 1 (Cold and Hot Switching) See Notes below: 1 & 2	+50 dBm @ +85 °C Case Temp
Peak Incident Power Handling Source & Load VSWR = 1.5 : 1 (Cold and Hot Switching) See Notes below: 1 & 2	+57 dBm @ 10 usec pulse, 1% duty cycle @ +85 °C Case Temp
Total Dissipated RF & DC Power (Cold Switching) See Notes below: 1 & 2	12 W @ +85 °C Case Temp

Notes:

- 1) For Hot Switching, PIN Diode Drivers must transition between states in less than 100 nsec with a parallel RC spiking network at the Driver Output.
- 2) Backside RF and DC grounding area of the MSW2T-206X-195 must be completely solder attached to the RF Circuit board for proper electrical and thermal circuit grounding.

MSW2T-2060-195 Small Signal Parametric Performance:

MSW2T-2060-195 Insertion Loss vs. Frequency

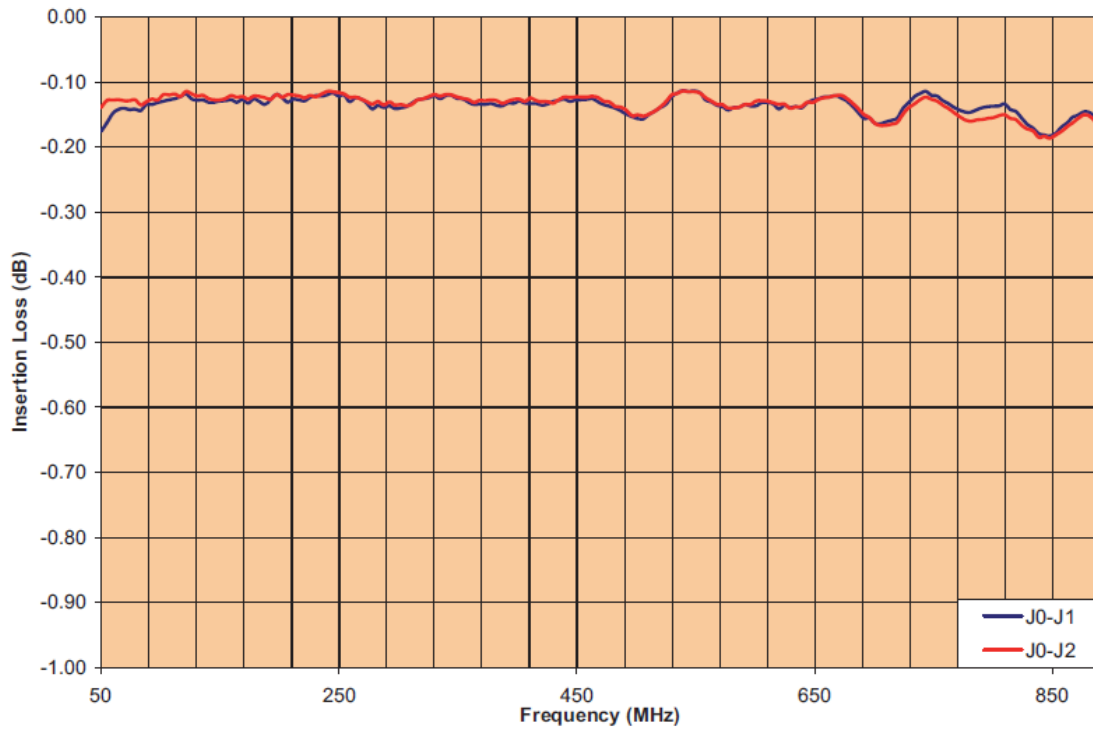

MSW2T-2060-195 Return Loss vs. Frequency

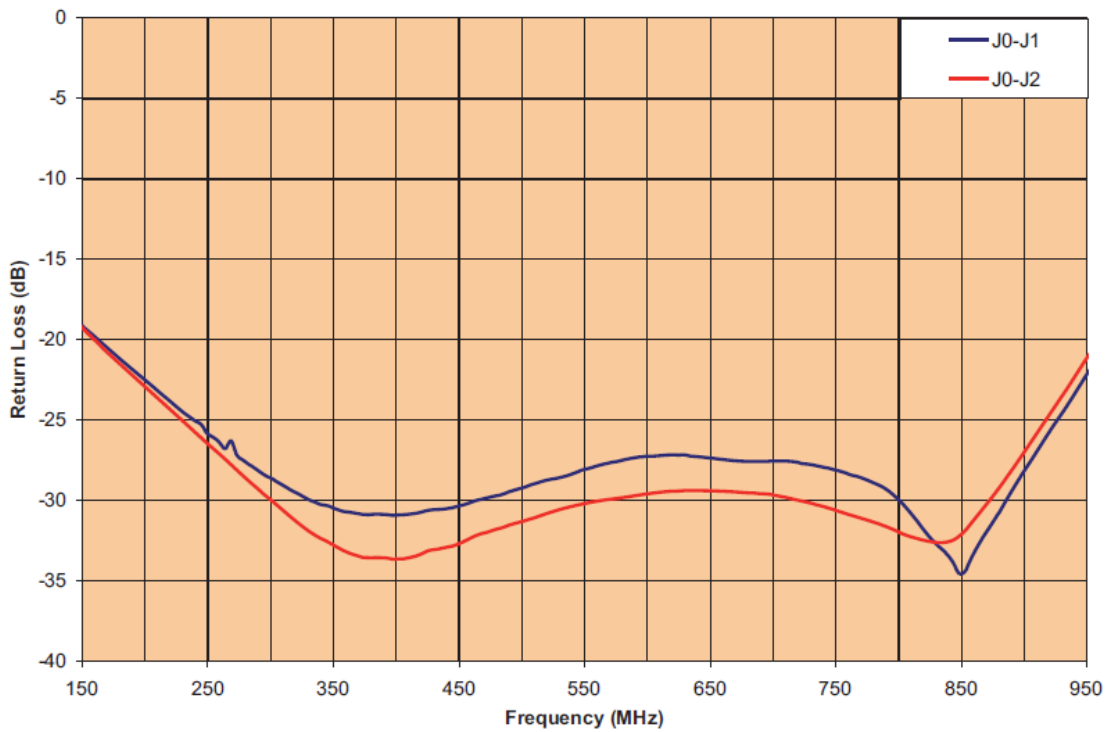

MSW2T-2060-195 Isolation vs. Frequency

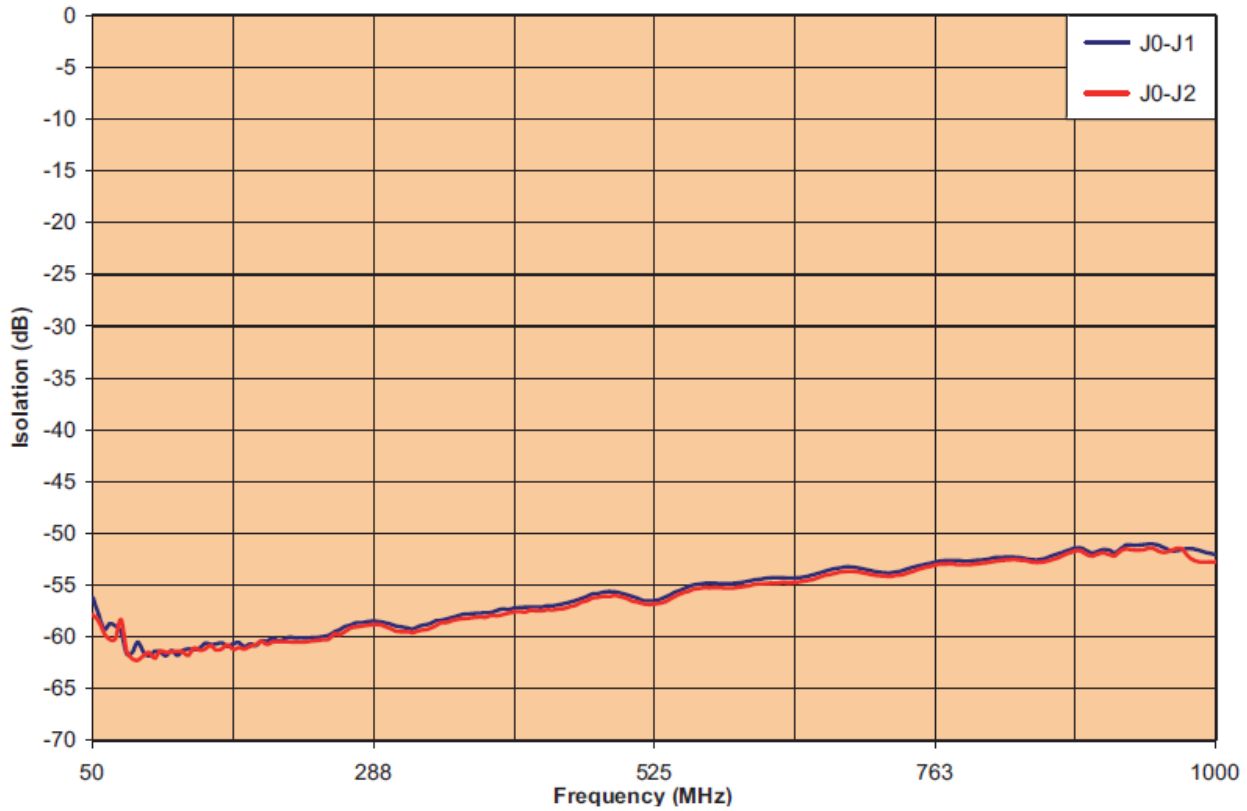

MSW2T-2061-195 Small Signal Parametric Performance:

MSW2T-2061-195 Insertion Loss vs. Frequency

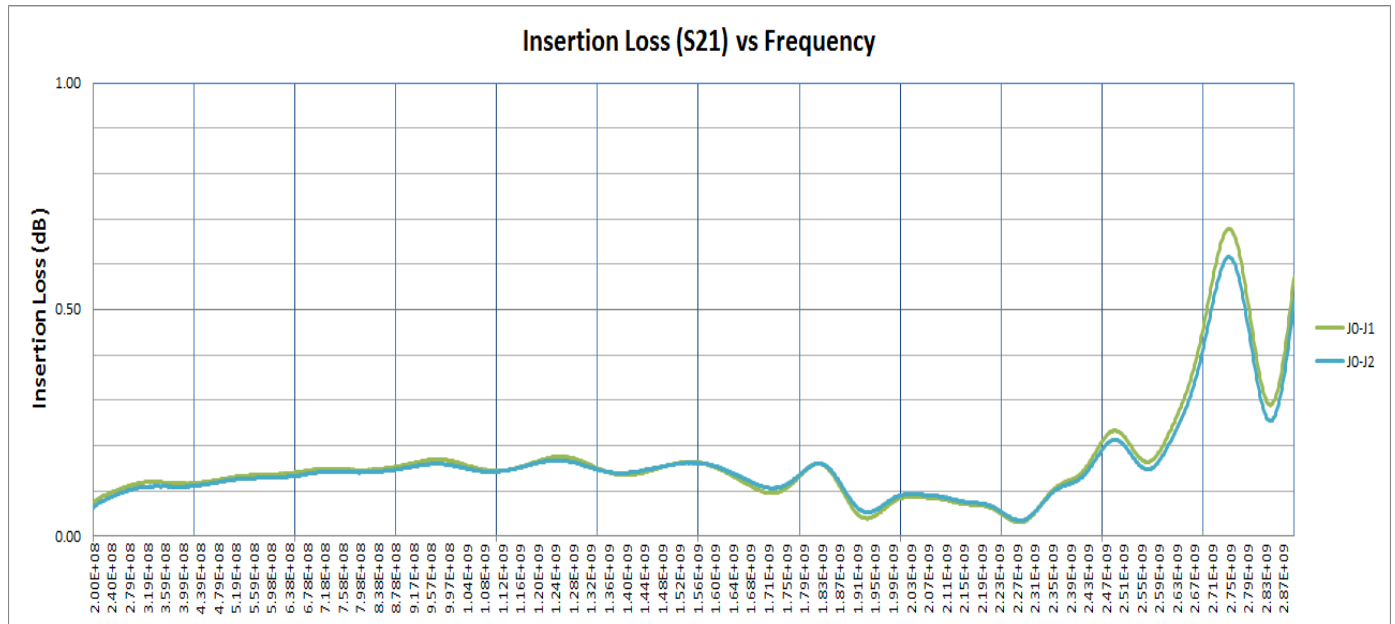

MSW2T-2061-195 Return Loss vs. Frequency

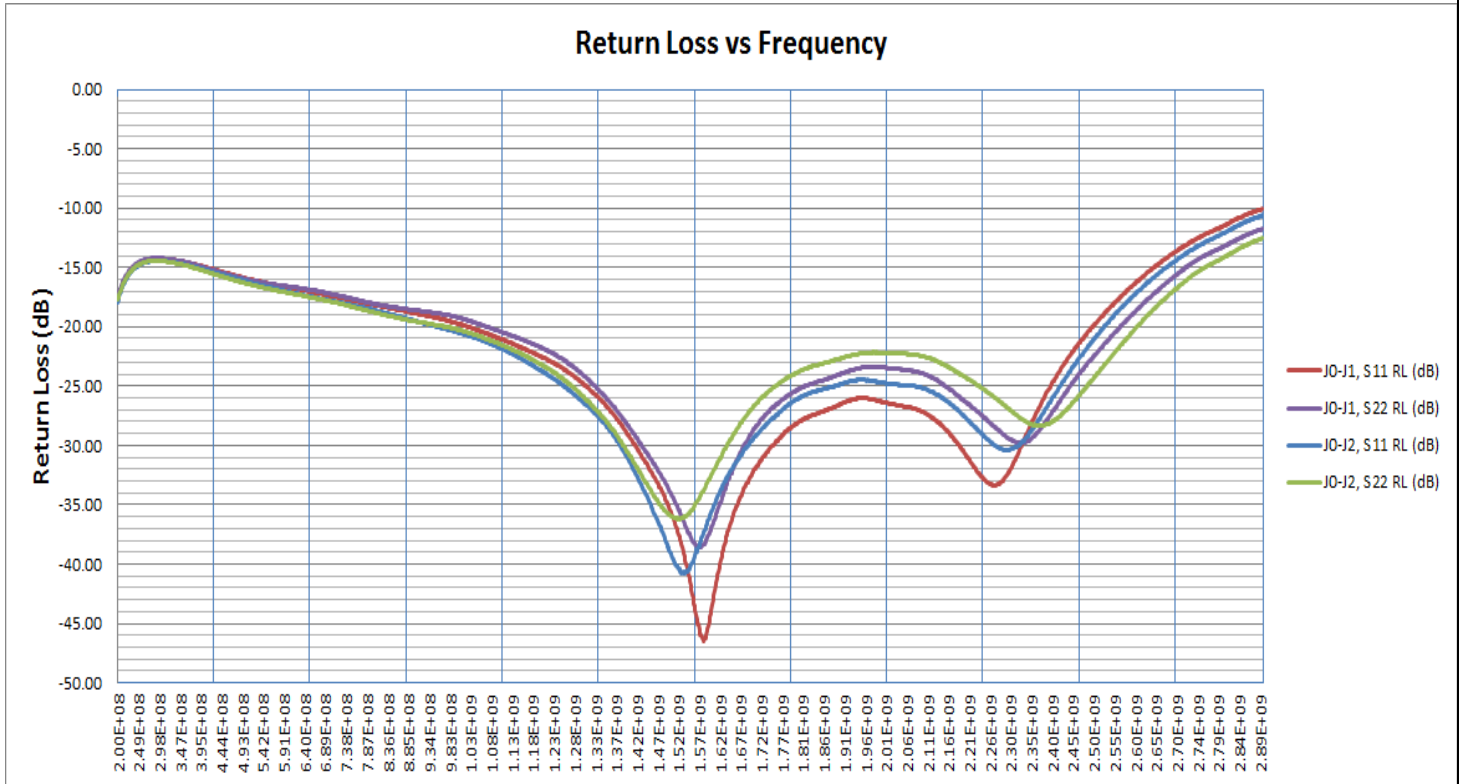

MSW2T-2061-195 Isolation vs. Frequency

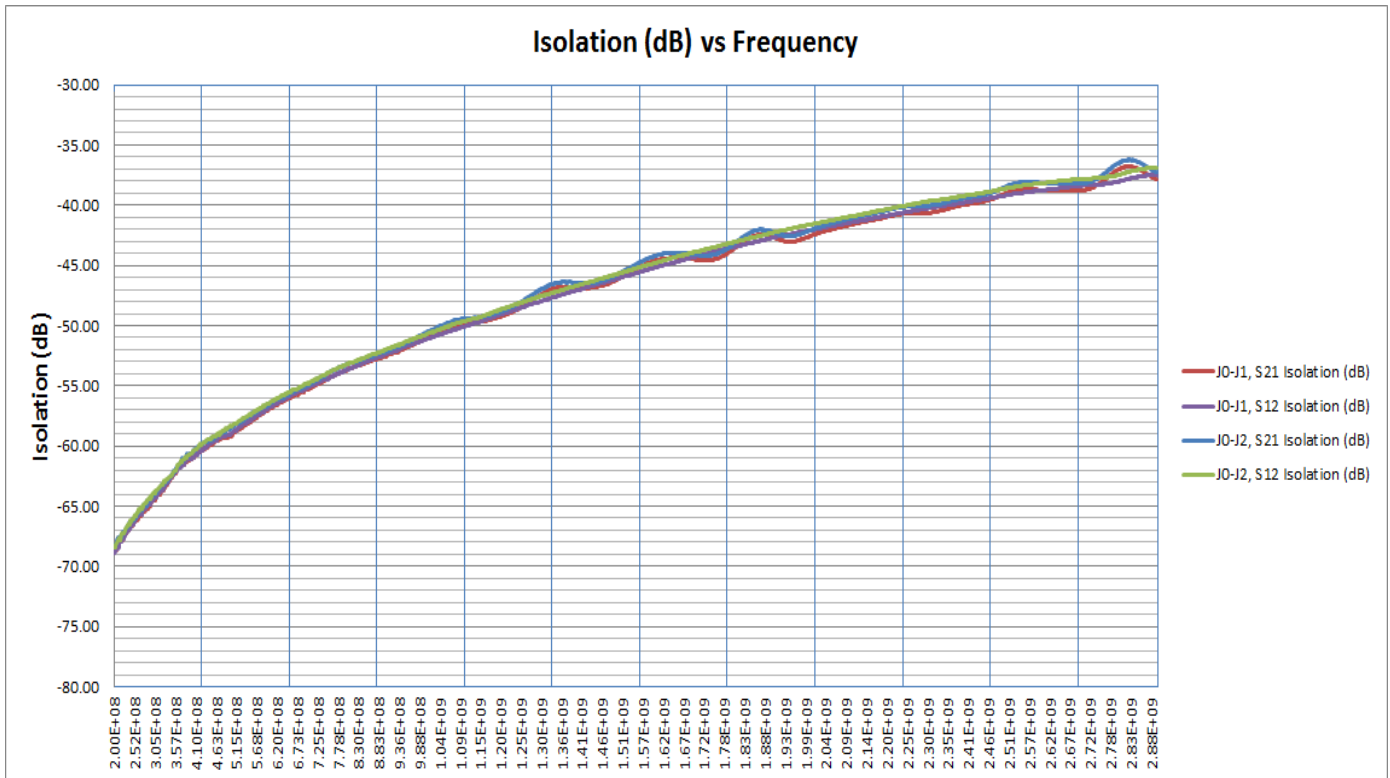

MSW2T-2062-195 Small Signal Parametric Performance:

MSW2T-2062-195 Insertion Loss vs. Frequency

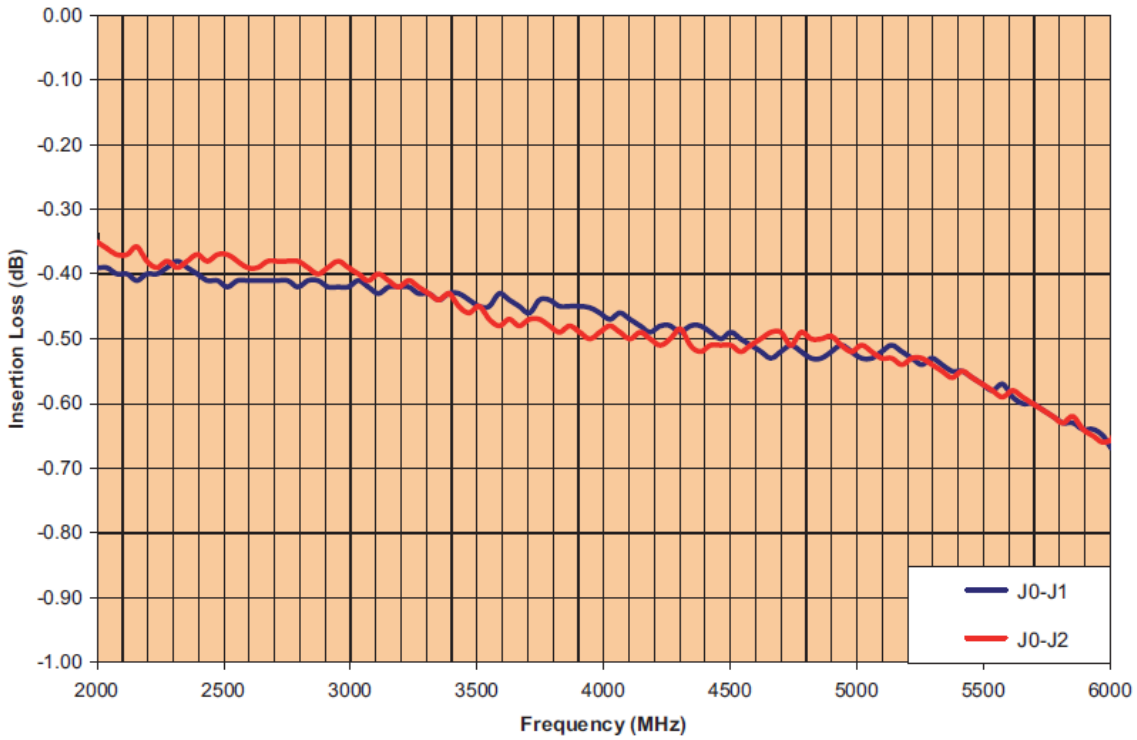

MSW2T-2062-195 Return Loss vs. Frequency

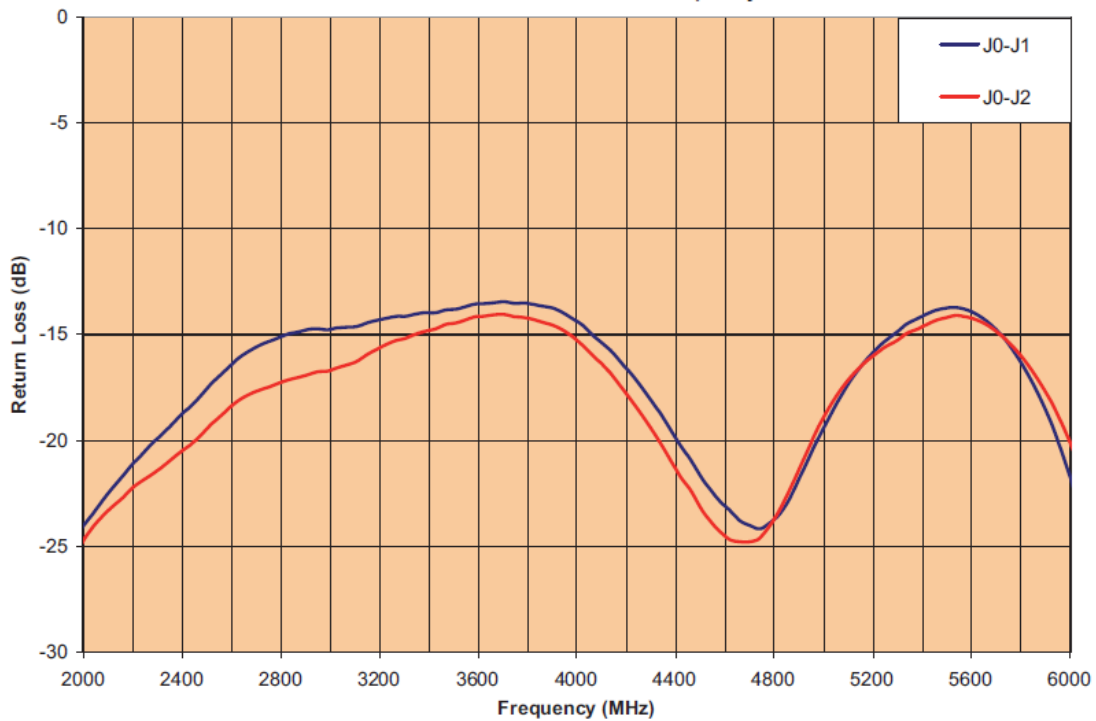

MSW2T-2062-195 Isolation vs. Frequency

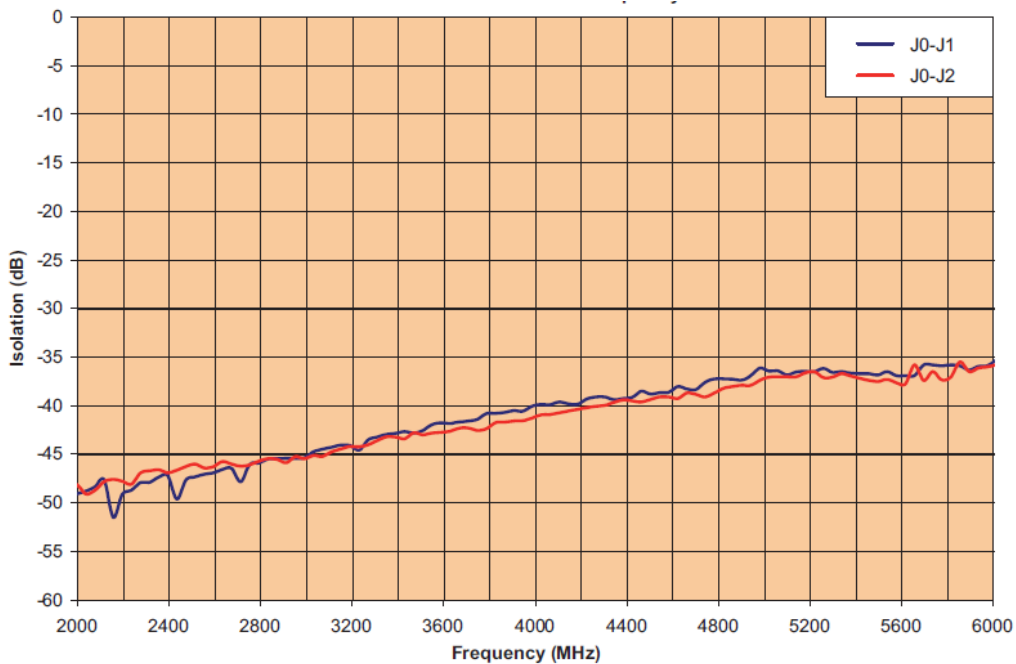

Assembly Instructions

The MSW2T-206X-195 family of High Power Switches are available in either tube or Tape & Reel format. The MSW2T-206X-195 may be attached to the printed circuit card using solder reflow procedures using either RoHS or Sn63/ Pb37 type solders per the Table and Temperature Profile Graph shown below:

Profile Parameter	Sn-Pb Assembly Technique	RoHS Assembly Technique
Average ramp-up rate (T_L to T_P)	3°C/sec (max)	3°C/sec (max)
Preheat		
Temp Min (T_{smin})	100°C	100°C
Temp Max (T_{smax})	150°C	150°C
Time (min to max) (t_s)	60 – 120 sec	60 – 120 sec
T_{smax} to T_L		
Ramp up Rate		3°C/sec (max)
Peak Temp (T_P)	225°C +0°C / -5°C	245°C +0°C / -5°C
Time within 5°C of Actual Peak Temp (T_P)	10 to 30 sec	20 to 40 sec
Time Maintained Above:		
Temp (T_L)	183°C	217°C
Time (t_L)	60 to 150 sec	60 to 150 sec
Ramp Down Rate	6°C/sec (max)	6°C/sec (max)
Time 25°C to T_P	6 minutes (max)	8 minutes (max)

Solder Re-Flow Time-Temperature Profile

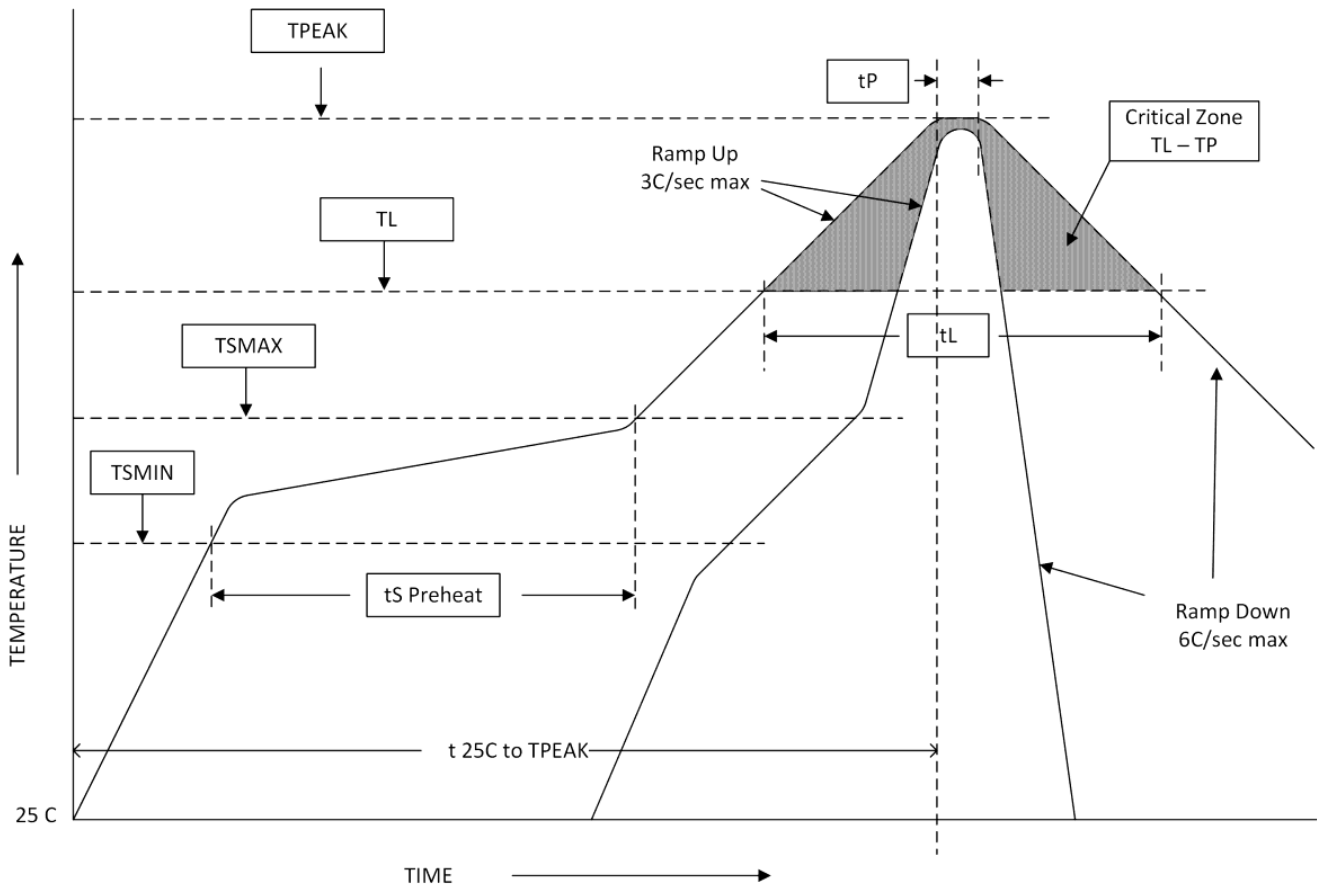

MSW2T-206X-195 SP2T Package Outline Drawing

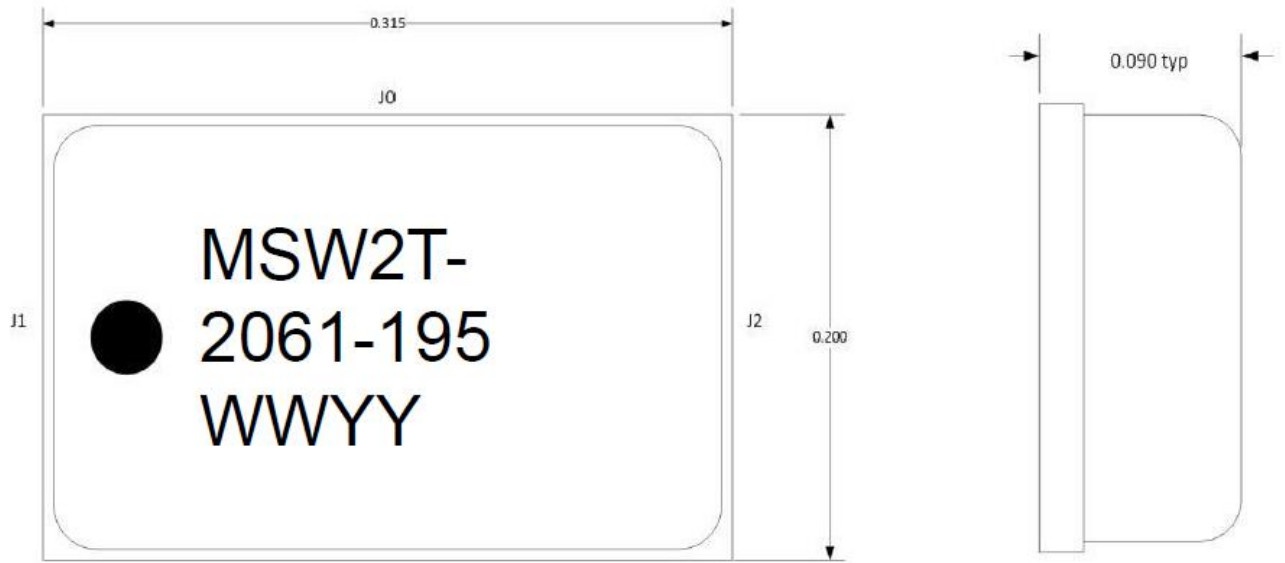

Side View

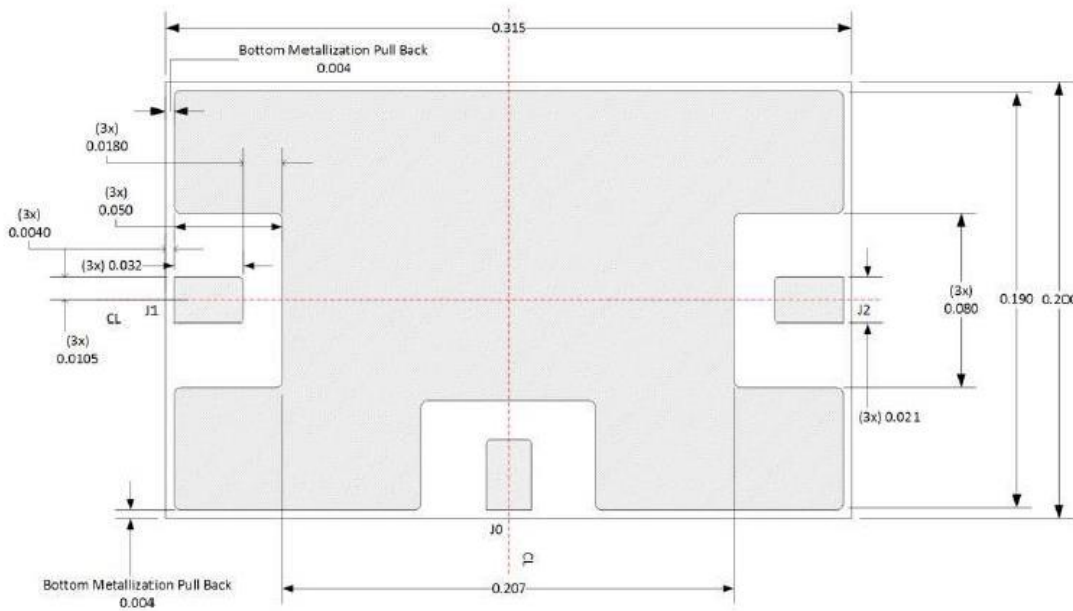

Note: Metalized area on backside is the RF, DC and Thermal ground. In user's end application this surface temperature must be managed to meet the power handling requirements.

Thermal Design Considerations:

The design of the MWT-206X-195 family of High Power Switches permits the maximum efficiency in thermal management of the PIN Diodes while maintaining extremely high reliability. Optimum switch performance and reliability of the switch can be achieved by the maintaining the base ground surface temperature of less than 85°C.

Recommended RF Circuit Solder Footprint for the MSW2T-206X-195

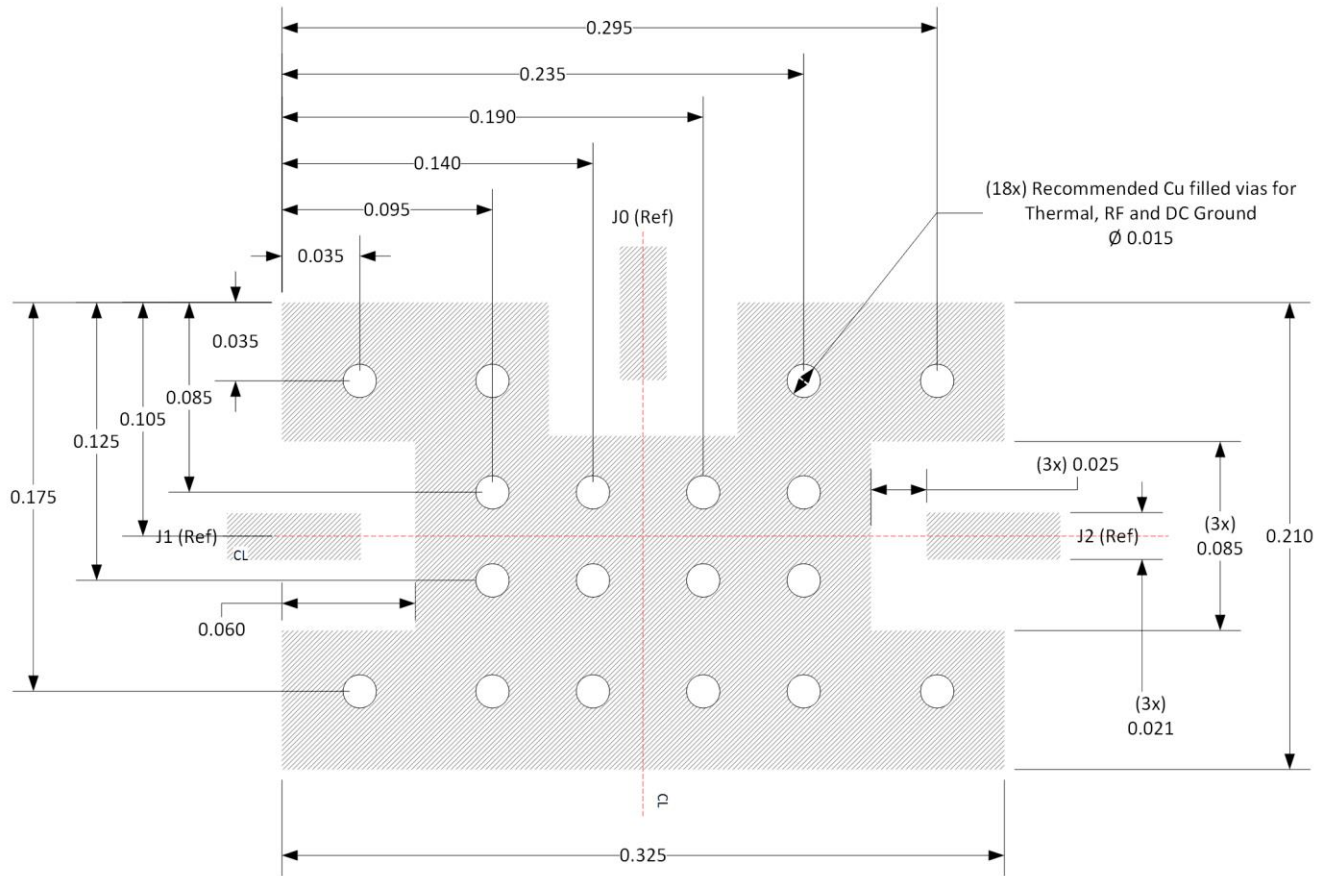

Part Number Ordering Details:

Part Number	Packaging
MSW2T-2060-195	Tube
MSW2T-2060-195TR	Tape & Reel (250 pcs)
MSW2T-2061-195	Tube
MSW2T-2061-195TR	Tape & Reel (250 pcs)
MSW2T-2062-195	Tube
MSW2T-2062-195TR	Tape & Reel (250 pcs)